

**DLC Display Co., Limited**

德爾西顯示器有限公司



MODEL No: DLC0430BCP10RF-R-2

TEL: 86-755-86029824

FAX: 86-755-86029827

E-MAIL: [sales@dlcdisplay.com](mailto:sales@dlcdisplay.com)

WEB: [www.dlcdisplay.com](http://www.dlcdisplay.com)



### Record of Revision

Date	Revision No.	Summary
2019-03-07	1.0	Rev 1.0 was issued

### 1. Scope

This data sheet is to introduce the specification of DLC0430BCP10RF-R-2 active matrix TFT module. It is composed of a color TFT-LCD panel, driver IC, FPC, RTP and a backlight unit. The 4.3" display area contains 480(RGB) x 272 pixels.

### 2. Application

Digital equipments which need color display, mobile navigator/video systems.

### 3. General Information

Item	Contents	Unit
Size	4.3	inch
Resolution	480 (RGB) x 272	/
Interface	RGB	/
Technology type	IPS	/
Pixel pitch	0.1188 x 0.1122	mm
Pixel Configuration	RGB stripes	
Outline Dimension (W x H x D)	105.50 x 67.20 x 3.95	mm
Active Area	95.04 x 53.86	mm
Display Mode	Transmissive	/
Backlight Type	LED	/
Viewing Direction	ALL	/
Driver IC	SC7283-G4	
Weight	TBD	g

### 4. Outline Drawing

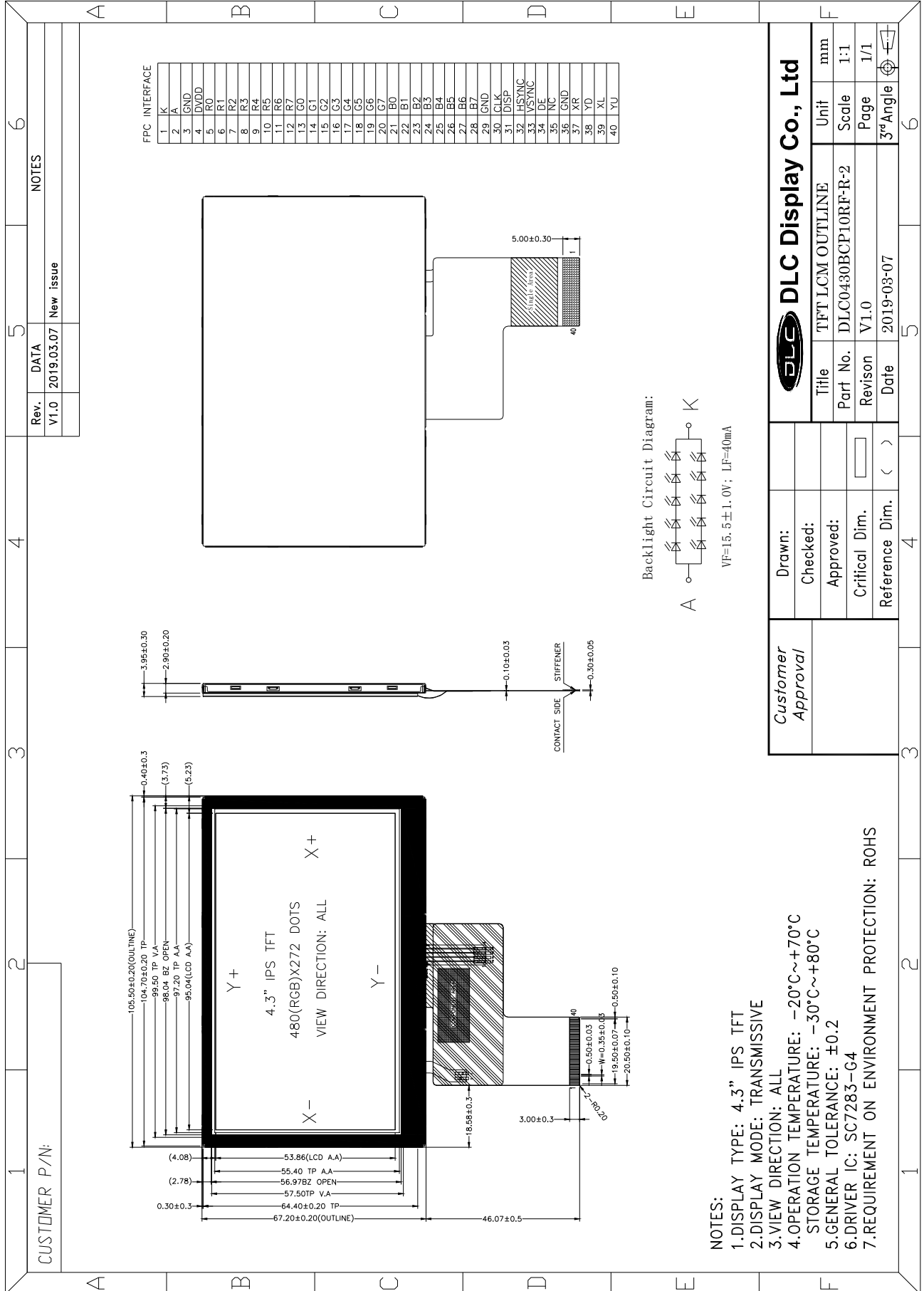

## 5. Interface signals

Pin No	Symbol	Function
1	K	Power for LED Backlight Cathode
2	A	Power for LED Backlight Anode
3	GND	Power ground
4	DVDD	Power Supply
5-12	R0-R7	Red Data
13-20	G0-G7	Green Data
21-28	B0-B7	Blue Data
29	GND	Power Ground
30	CLK	Pixel clock
31	DISP	standby mode selection, low active
32	HSYNC	Horizontal sync signal
33	VSYNC	Vertical sync signal
34	DE	Data enable
35	NC	No Connection
36	GND	Power Ground
37	XR	Touch Panel Control Pin
38	YD	
39	XL	
40	YU	

## 6. Absolute maximum Ratings

### 6.1. Electrical Absolute max. ratings

Parameter	Symbol	MIN	MAX	Unit	Remark
Logic Supply Voltage	DVDD	-0.3	5.0	V	
Input Voltage	VIN	-0.3	5.0	V	

Note1: The driver IC may be permanently damaged if it is used under the condition exceeding the above absolute maximum values. It is also recommended to use the driver IC within the limit of its electric characteristics during normal operation. Exceeding the conditions may lead to malfunction of it and affect its credibility.

Note2: The voltage from VSS.

### 6.2. Environment Conditions

Item	Symbol	MIN	MAX	Unit	Remark
Operating Temperature	TOPR	-20	70	°C	
Storage Temperature	TSTG	-30	80	°C	

## 7. Electrical Specifications

### 7.1 Electrical characteristics

Ta = 25 °C, GND=0V

Item	Symbol	MIN	TYP	MAX	Unit	Remark
Supply Voltage	DVDD	3.0	3.3	3.6	V	
Input Signal Voltage	VIL	GND	--	0.3*DVDD	V	DVDD=3.0~3.6V
	VIH	0.7*DVDD	--	DVDD	V	
LCD drive power current	ILCD	--	--	24	mA	DVDD=3.3V

Note1: Vcom must be adjusted to optimize display quality: Cross-talk, Contrast Ratio and etc.

### 7.2 LED Backlight

Ta=25°C

Item	Symbol	MIN	TYP	MAX	Unit	Remark
Forward Current	IF	--	40	--	Ma	
Forward Voltage	VF	14.5	15.5	16.5	V	If=40mA
LED Life time	-	-	30,000	-	Hrs	Note

Note: The "LED life time" is defined as the module brightness decrease to 50% original brightness at Ta=25°C and IF=40mA. The LED life time could be decreased if operating IF is larger than 40mA.

Backlight Circuit Diagram:

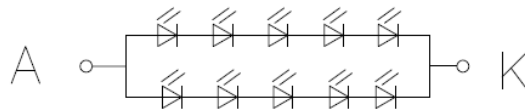

VF=15.5 ± 1.0V; LF=40mA

### 7.3 Schematic of LCD module system

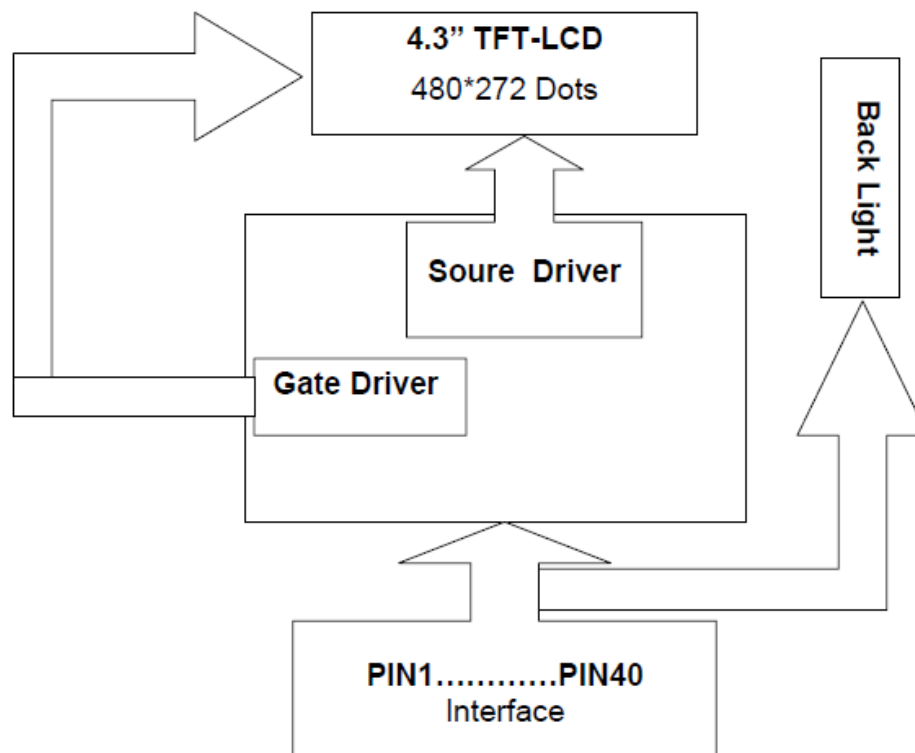

## 8. Command/AC Timing

### 8.1 AC Characteristics

Item	Symbol	Min.	Typ.	Max.	Unit	Conditions
CLK Pulse Duty	tcw	40	50	60	%	
HSYNC width	thw	2	-	-	DCLK	
HSYNC period	th	55	60	65	us	
VSYNC setup time	tvst	12			ns	
VSYNC hold time	tvhd	12			ns	
HSYNC setup time	thst	12			ns	
HSYNC hold time	thhd	12			ns	
Data setup time	tdsu	12			ns	
Data hold time	tdhd	12			ns	
DE setup time	tdest	12			ns	
DE hold time	tdehd	12			ns	

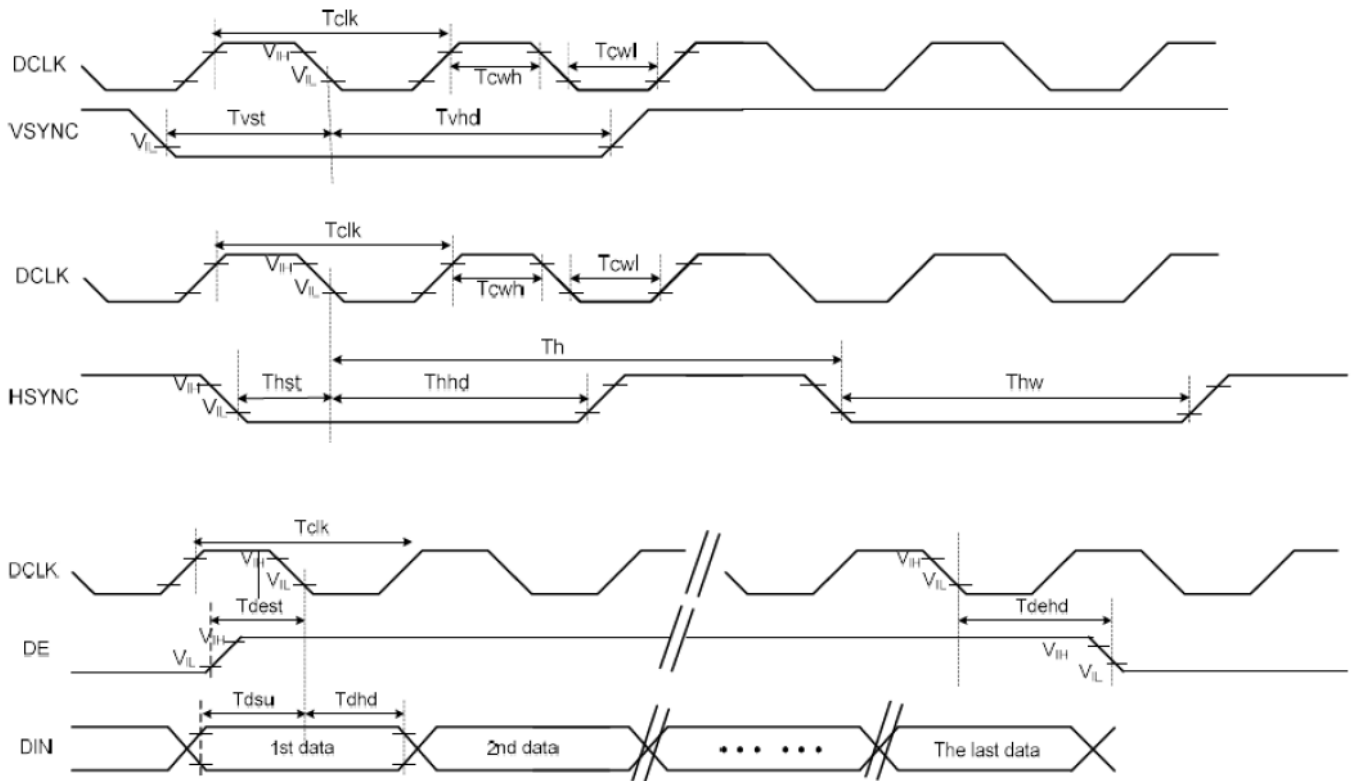

## 8.2 Power ON/OFF Sequence

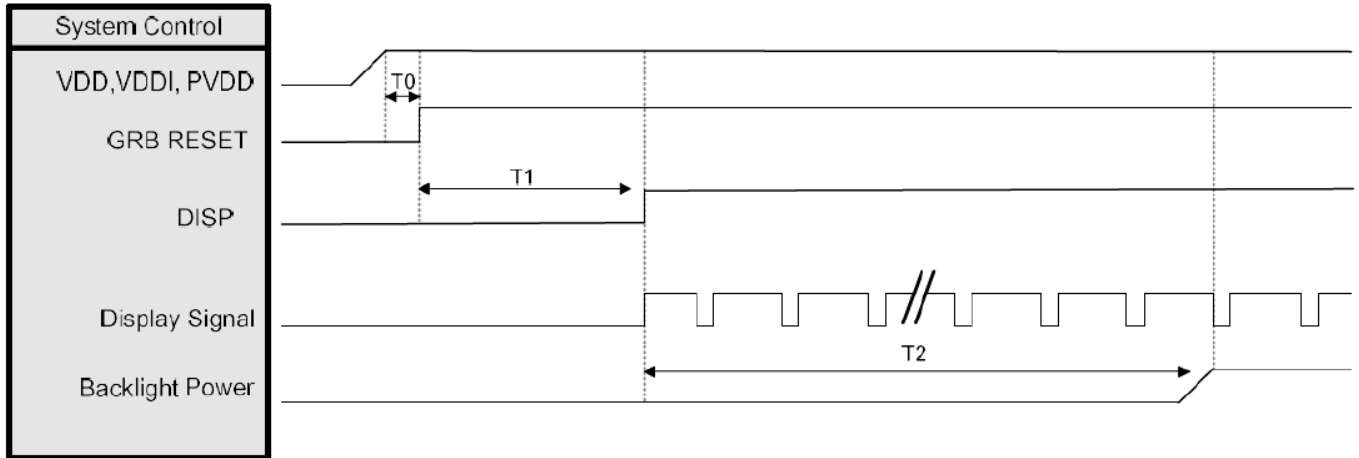

Symbol	Symbol	Min. Time	Unit
T0	System power stability to GRB RESET signal	0	ms
T1	GRB RESET="High" to DISP="High"	10	ms
T2	Display signal output to backlight power on	250	ms

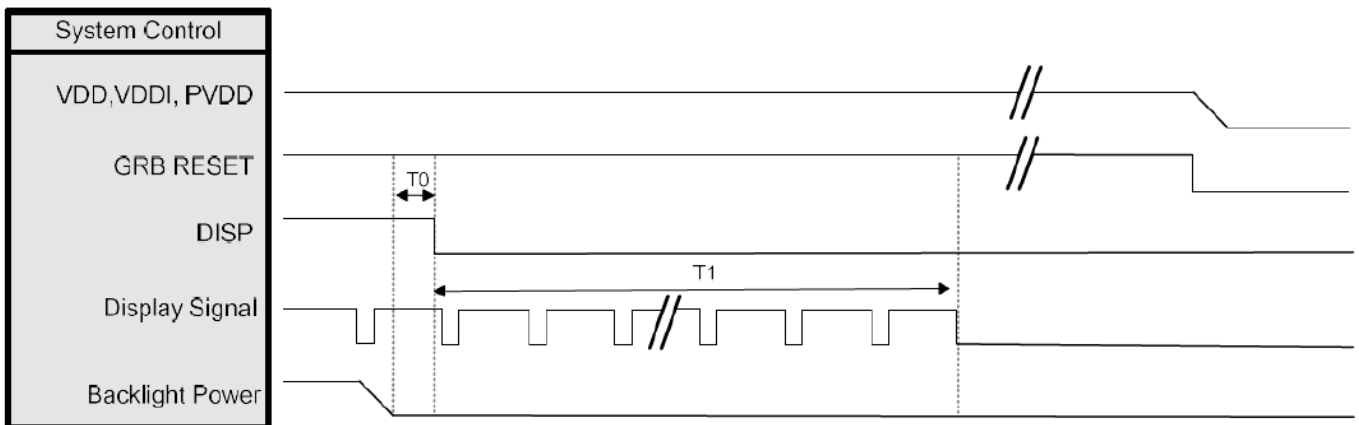

Symbol	Symbol	Min. Time	Unit
T0	Backlight Power off to DISP="Low"	5	ms
T1	DISP="Low" to IC Internal voltage discharge complete	80	ms



## 9. Optical Specification

Ta=25°C

Item	Symbol	Condition	Min	Typ.	Max.	Unit	Remark
Contrast Ratio	CR	$\theta=0^\circ$	640	800	-		Note1 Note2
Response Time	Ton/ Toff	25°C	-	30	40	ms	Note1 Note3
View Angles	$\Theta T$	$CR \geq 10$	70	80	-	Degree	Note 4
	$\Theta B$		70	80	-		
	$\Theta L$		70	80	-		
	$\Theta R$		70	80	-		
Chromaticity	White	Brightness is on	x	0.320	-		Note5, Note1
			y	0.345	-		
	Red		x	0.629	-		
			y	0.326	-		
	Green		x	0.337	-		
			y	0.546	-		
	Blue		x	0.136	-		
			y	0.143	-		
Luminance	L		-	320	-	cd/m <sup>2</sup>	Note1 Note6
Uniformity	U		80	-	-	%	Note1 Note7

Note 1: Definition of optical measurement system.

Temperature = 25°C(±3°C)

LED back-light: ON, Environment brightness < 150 lx

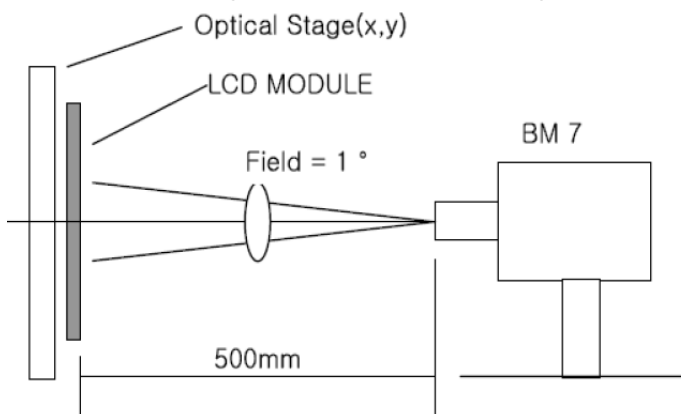

Note 2: Contrast ratio is defined as follow:

$$\text{Contrast Ratio} = \frac{\text{Surface Luminance with all white pixels}}{\text{Surface Luminance with all black pixels}}$$

Note 3: Response time is defined as follow:

Response time is the time required for the display to transition from black to white (Rise Time, Tr) and from

white to black(Decay Time, Tf).

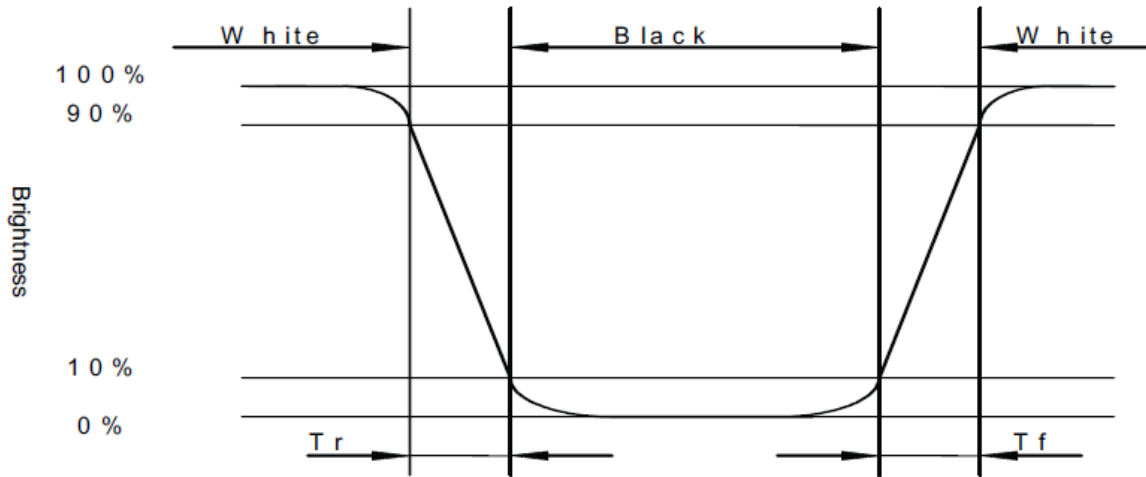

Note 4: Viewing angle range is defined as follow:

Viewing angle is measured at the center point of the LCD.

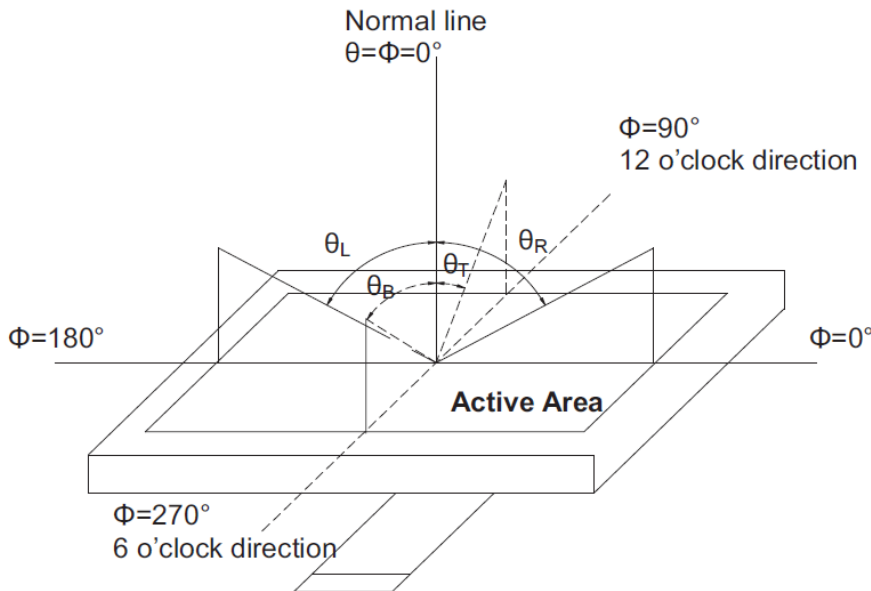

Note 5: Color chromaticity is defined as follow: (CIE1931)

Color coordinates measured at center point of LCD.

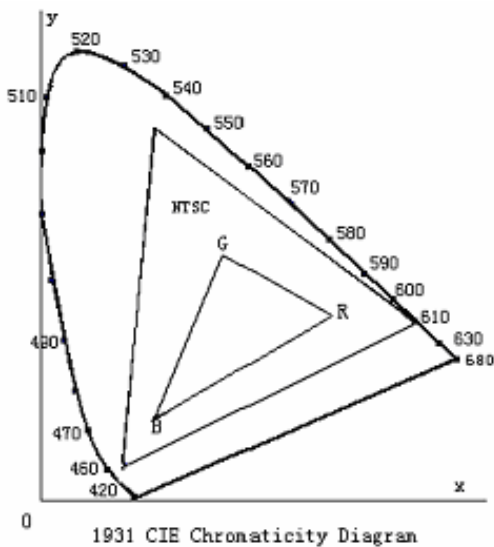

$$S = \frac{\text{area of RGB triangle}}{\text{area of NTSC triangle}} \times 100\%$$

Note 6: Luminance is defined as follow:

Luminance is defined as the brightness of all pixels “White” at the center of display area on optimum contrast.

Note 7: Luminance Uniformity is defined as follow:

Active area is divided into 9 measuring areas (Refer Fig. 2). Every measuring point is placed at the center of each measuring area.

$$\text{Uniformity (U)} = \frac{\text{Minimum Luminance( brightness ) in 9 points}}{\text{Maximum Luminance( brightness ) in 9 points}}$$

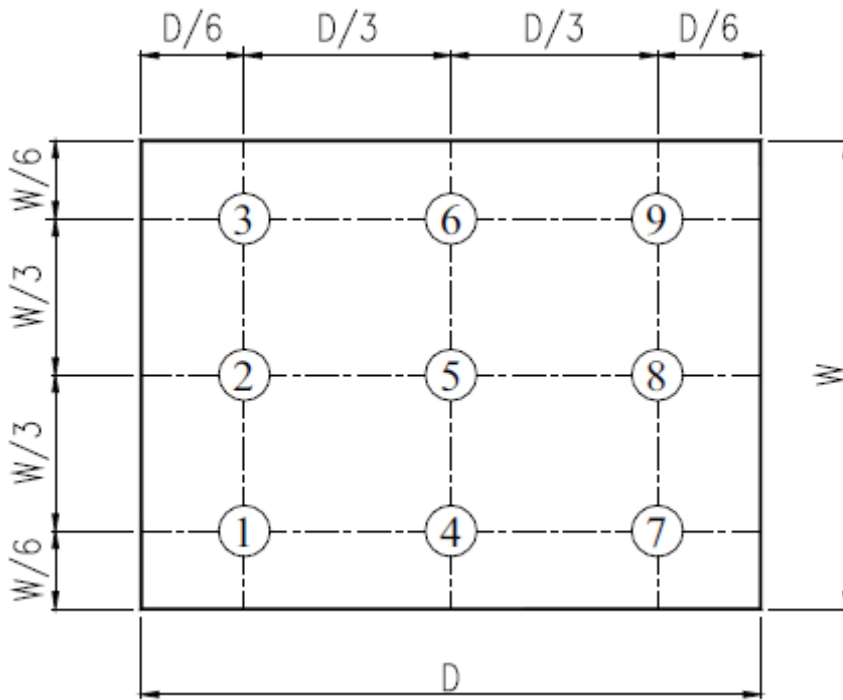

Fig. 2 Definition of uniformity

## 10. Environmental / Reliability Tests

No	Test Item	Condition	Judgment criteria
1	High Temp Operation	Ts=+70°C, 96hrs	Per table in below
2	Low Temp Operation	Ta=-20°C, 96hrs	Per table in below
3	High Temp Storage	Ta=+80°C, 96hrs	Per table in below
4	Low Temp Storage	Ta=-30°C, 96hrs	Per table in below
5	High Temp & High Humidity Storage	Ta=+60°C, 90% RH 96hours	Per table in below (polarizer discoloration is excluded)
6	Thermal Shock (Non-operation)	-30°C 30 min~+80°C 30 min, Change time:5min, 10 Cycles	Per table in below
7	ESD (Operation)	C=150pF, R=330Ω · 5points/panel Air:±8KV, 5times; Contact:±4KV, 5 times;	Per table in below
8	Vibration (Non-operation)	Frequency range:10~55Hz, Stroke:1.5mm Sweep:10Hz~55Hz~10Hz 2 hours for each direction of X.Y.Z.	Per table in below
9	Shock (Non-operation)	60G 6ms, ±X,±Y,±Z 3times, for each direction	Per table in below
10	Package Drop Test	Height:80 cm, 1 corner, 3 edges, 6 surfaces	Per table in below

INSPECTION	CRITERION(after test)
Appearance	No Crack on the FPC, on the LCD Panel
Alignment of LCD Panel	No Bubbles in the LCD Panel No other Defects of Alignment in Active area
Electrical current	Within device specifications
Function / Display	No Broken Circuit, No Short Circuit or No Black line No Other Defects of Display

## 11. Precautions for Use of LCD Modules

### 11.1 Safety

The liquid crystal in the LCD is poisonous. Do not put it in your mouth. If the liquid crystal touches your skin or clothes, wash it off immediately using soap and water.

### 11.2 Handling

- A. The LCD and touch panel is made of plate glass. Do not subject the panel to mechanical shock or to excessive force on its surface.
- B. Do not handle the product by holding the flexible pattern portion in order to assure the reliability
- C. Transparency is an important factor for the touch panel. Please wear clear finger sacks, gloves and mask to protect the touch panel from finger print or stain and also hold the portion outside the view area when handling the touch panel.
- D. Provide a space so that the panel does not come into contact with other components.
- E. To protect the product from external force, put a covering lens (acrylic board or similar board) and keep an appropriate gap between them.
- F. Transparent electrodes may be disconnected if the panel is used under environmental conditions where dew condensation occurs.
- G. Property of semiconductor devices may be affected when they are exposed to light, possibly resulting in IC malfunctions.
- H. To prevent such IC malfunctions, your design and mounting layout shall be done in the way that the IC is not exposed to light in actual use.

### 11.3 Static Electricity

- A. Ground soldering iron tips, tools and testers when they are in operation.
- B. Ground your body when handling the products.
- C. Power on the LCD module before applying the voltage to the input terminals.
- D. Do not apply voltage which exceeds the absolute maximum rating.
- E. Store the products in an anti-electrostatic bag or container.
- F. Peel off the LCM protective film slowly since static electricity may be generated.

### 11.4 Storage

- A. Store the products in a dark place at  $+25^{\circ}\text{C} \pm 10^{\circ}\text{C}$  with low humidity (40% RH to 60% RH). Don't expose to sunlight or fluorescent light.
- B. Storage in a clean environment, free from dust, active gas, and solvent.

### 11.5 Cleaning

- A. Do not wipe the touch panel with dry cloth, as it may cause scratch.
- B. Wipe off the stain on the product by using soft cloth moistened with ethanol. Do not allow ethanol to get in between the upper film and the bottom glass. It may cause peeling issue or defective operation. Do not use any organic solvent or detergent other than ethanol.

### 11.6 Cautions for installing and assembling

- A. Bezel edge must be positioned in the area between the Active area and View area. The bezel may press the touch screen and cause activation if the edge touches the active area. A gap of approximately 0.5mm is needed between the bezel and the top electrode. It may cause unexpected activation if the gap is too narrow. There is a tolerance of 0.2 to 0.3mm for the outside dimensions of the touch panel and tail. A gap must be made to absorb the tolerance in the case and connector.
- B. In order to make the display assembly stable and firm, DLC recommends to design some supporting at the display backside, especially for the display with tape-attached touch panel, such supporting is important and essential, or else, the display may drop-off from front after some period of time.
- C. Do not display the fixed pattern for a long time because it may develop image sticking due to the LCD structure. If the screen is displayed with fixed pattern, use a screen saver.

